



Overview

KEMET's A928 is an electrolytic capacitor module with outstanding electrical performance, high ripple current, and high energy storage capabilities. This device contains a bank of PEH228 Radial Crown Aluminum Electrolytic Capacitors mounted on a copper bus bar. These assembled parts are housed by a plastic case. The A928's low ESR is the result of a low resistive electrolyte/paper system and an all-welded design. Optimal bus bar design enables a low ESL level. The A928 is suitable for use in automotive applications, thanks to its mechanical robustness. One example would be in 48V inverter applications for Mild Hybrid Electric Vehicles, especially because of its 150°C temperature rating. This modular device facilitates the integration on an application heat-sink. KEMET's automotive grade capacitors meet the demanding Automotive Electronics Council's AEC-Q200 qualification requirements.

Benefits

- Capacitor bank ready to fit into application
- AEC-Q200 automotive qualified
- 2,000 hours at +150°C
- Extremely high ripple current
- Up to 136 ARMS ripple current, continuous load
- ESR stability over lifetime
- Low ESL
- High vibration resistance
- Outstanding electrical performance

Applications

The KEMET A928 is an electrolytic capacitor module, designed for automotive applications with extremely high demands and focused on 48V Mild Hybrid Electric Vehicle Inverters.

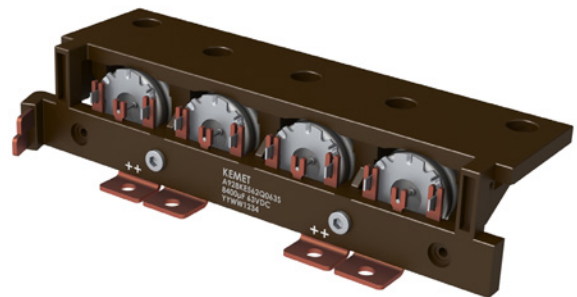

Part Number System

A	928	MF	113	Q	063	W
Capacitor Class	Series	Size Code	Capacitance Code (µF)	Tolerance	Rated Voltage (VDC)	Termination
A = Aluminum	Aluminum Electrolytic Capacitor Module	See Dimension Table	First two digits represent significant figures. Third digit specifies number of zeros.	Q = -10 + 30%	063 = 63 V	W = Welding S = Screw

Performance Characteristics

Item	Performance Characteristics	
Capacitance Range	4,200 – 11,000 μ F	
Rated Voltage	63 VDC	
Operating Temperature	-40 to +150°C	
Capacitance Tolerance	-10/+30%, (\pm 20% select values) at 100 Hz/+20°C	
Operational Lifetime	Rated voltage, +125°C (hours)	Rated voltage, +150°C (hours)
	8,400	2,000
Shelf Life	5,000 hours at +105°C or 10 years at +40°C 0 VDC	
Leakage Current	$I = 0.003 CV$ (μ A)	
	C = rated capacitance (μ F), V = rated voltage (VDC). Voltage applied for 5 minutes at +20°C.	
Vibration Test Specifications	Procedure	Requirements
	1.5 mm displacement amplitude or 20 g maximum acceleration. Vibration applied for three 22-hour sessions at 10 – 2,000 Hz	No leakage of electrolyte or other visible damage. Deviations in capacitance from initial measurements must not exceed: $\Delta C/C < 5\%$
Standards	IEC 60384-4 long life grade 40/125/56, AEC-Q200	

Compensation Factor of Ripple Current (RC) vs. Frequency

Frequency	100 Hz	300 Hz	1 kHz	5 kHz	100 kHz
Coefficient	0.35	0.57	0.80	1.00	1.04

Test Method & Performance

Endurance Life Test	
Conditions	Performance
Temperature	+150°C
Test Duration	2,000 hours
Ripple Current	Maximum ripple current specified in table
Voltage	The sum of DC voltage and the peak AC voltage must not exceed the rated voltage of the capacitor
Performance	The following specifications will be satisfied when the capacitor is tested at +20°C:
Capacitance Change	Within 15% of the initial value
Equivalent Series Resistance	$\leq 2x$ initial value (typically $\leq 1.3x$ at 90% of the lifetime)
Leakage Current	Does not exceed leakage current limit

Dimensions – Millimeters

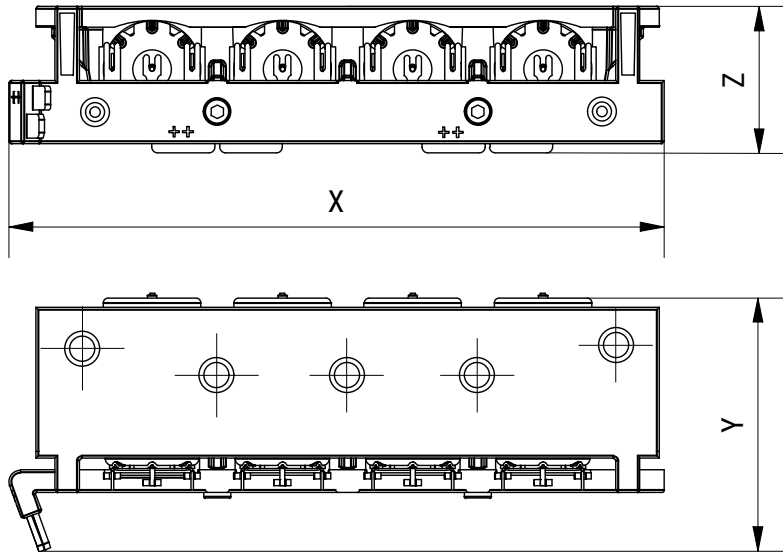

Size Code	Dimensions in mm			Approximate Weight Grams
	X ±1	Y ±1	Z ±1	
JE	108.0	52.0	31.0	103
JF	108.0	60.0	31.0	115
KE	135.0	52.0	31.0	129
KF	135.0	60.0	31.0	144
LE	162.0	52.0	31.0	155
LF	162.0	60.0	31.0	173
ME	189.0	52.0	31.0	181
MF	189.0	60.0	31.0	202

Dimensions – Millimeters cont.

Welded Termination

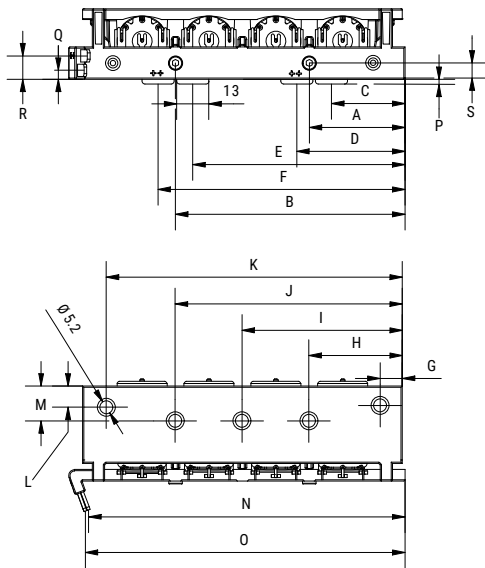

Screw Termination

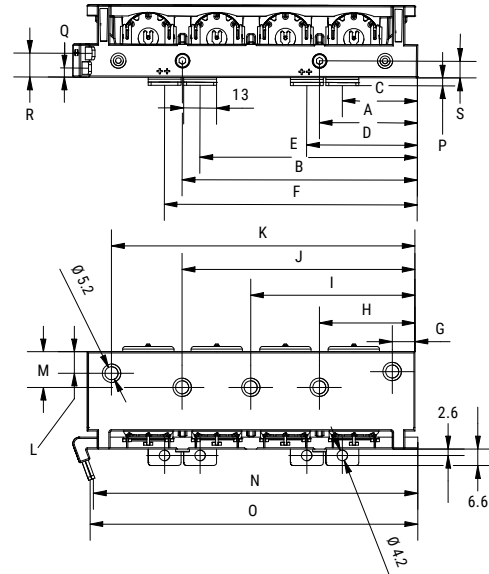

Dimension (mm)	Size Code			
	JE, JF	KE, KF	LE, LF	ME, MF
A	38.6	38.6	38.6	38.6
B	65.4	92.6	119.6	146.6
C	19.7	29.7	29.7	29.7
D	33.7	43.7	43.7	43.7
E	69.4	85.7	112.7	139.7
F	82.8	99.7	126.7	153.7
G	9.0	9.0	9.0	9.0
H	37.4	37.4	64.4	37.4
I	64.4	64.4	64.4	91.4
J	92.1	92.1	146.1	173.1
K	92.1	119.1	146.1	173.1
L	8.5	8.5	8.5	8.5
M	14.0	14.0	14.0	14.0
N	100.7	127.7	154.7	181.7
O	102.0	129.0	156.0	183.0
P	2.0	2.0	2.0	2.0
Q	3.6	3.6	3.6	3.6
R	9.4	9.4	9.4	9.4
S	6.0	6.0	6.0	6.0

Shelf Life

The capacitance, ESR and impedance of a capacitor will not change significantly after extended storage periods, however, the leakage current will very slowly increase. KEMET products are particularly stable and allow a shelf life in excess of ten years at 40°C. See sectional specification under each product for specific data.

Reliability

Estimated field failure rate:

Size Codes	Estimated field failure rate \leq (ppm)*
JE, JF	0.45
KE, KF	0.60
LE, LF	0.75
ME, MF	0.90

(*Failures per year/produced number of capacitors per year)

The expected failure rate for this capacitor module range is based on field experience for single capacitors with structural similarity.

Environmental Compliance



All Part Numbers in this datasheet are Reach and RoHS compliant and Halogen-Free.

As an environmentally conscious company, KEMET is working continuously with improvements concerning the environmental effects of both our capacitors and their production.

In Europe (RoHS Directive) and in some other geographical areas such as China, legislation has been put in place to prevent the use of some hazardous materials, such as lead (Pb), in electronic equipment. All products in this catalog are produced to help our customers' obligations to guarantee their products and fulfill these legislative requirements. The only material of concern in our products has been lead (Pb), which has been removed from all designs to fulfill the requirement of containing less than 0.1% of lead in any homogeneous material. KEMET will closely follow any changes in legislation world wide and makes any necessary changes in its products, whenever needed.

Some customer segments such as medical, military, and automotive electronics may still require the use of lead in electrode coatings. To clarify the situation and distinguish products from each other, a special symbol is used on the packaging labels for RoHS compatible capacitors.

Due to customer requirements, there may appear additional markings such as lead-free (LF) or lead-free wires (LFW) on the label.

Table 1 – Ratings & Part Number Reference

Rated Voltage	Rated Capacitance	Size Code	Case Size	Ripple Current			ESR			Part Number
				Maximum			Maximum			
(VDC)	100 Hz 20°C (µF)		X x Y x Z (mm)	≥ 5 kHz 125°C (A) ¹	≥ 5 kHz 140°C (A) ¹	≥ 5 kHz 150°C (A) ¹	100 Hz 20°C (mΩ)	100 kHz 20°C (mΩ)	5-100 kHz 125-150°C (mΩ)	() Represents Part Number Options
63	4,200	JE	108 x 52 x 31	63.3	39.9	18.0	18.1	7.1	4.4	A928JE432Q063(1)
63	5,400	JF	108 x 60 x 31	68.1	43.2	19.2	14.4	5.9	3.9	A928JF542Q063(1)
63	5,600	KE	135 x 52 x 31	84.4	53.2	24.0	13.7	5.5	3.4	A928KE562Q063(1)
63	7,200	KF	135 x 60 x 31	90.8	57.6	25.6	10.9	4.6	3.0	A928KF722Q063(1)
63	7,000	LE	162 x 52 x 31	105.5	66.5	30.0	11.0	4.5	2.8	A928LE702Q063(1)
63	9,000	LF	162 x 60 x 31	113.5	72.0	32.0	8.8	3.7	2.5	A928LF902Q063(1)
63	8,400	ME	189 x 52 x 31	126.6	79.8	36.0	9.3	3.8	2.5	A928ME842Q063(1)
63	11,000	MF	189 x 60 x 31	136.2	86.4	38.4	7.5	3.2	2.2	A928MF113Q063(1)

¹ Capacitor-mounted with low thermal resistance path (heat-sink).

(1) Output terminals code. See Part Number System for available options.

Marking

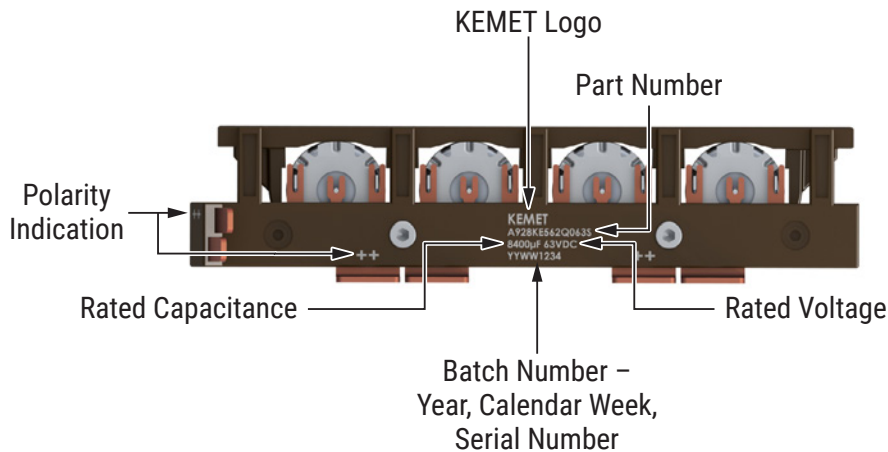

Construction

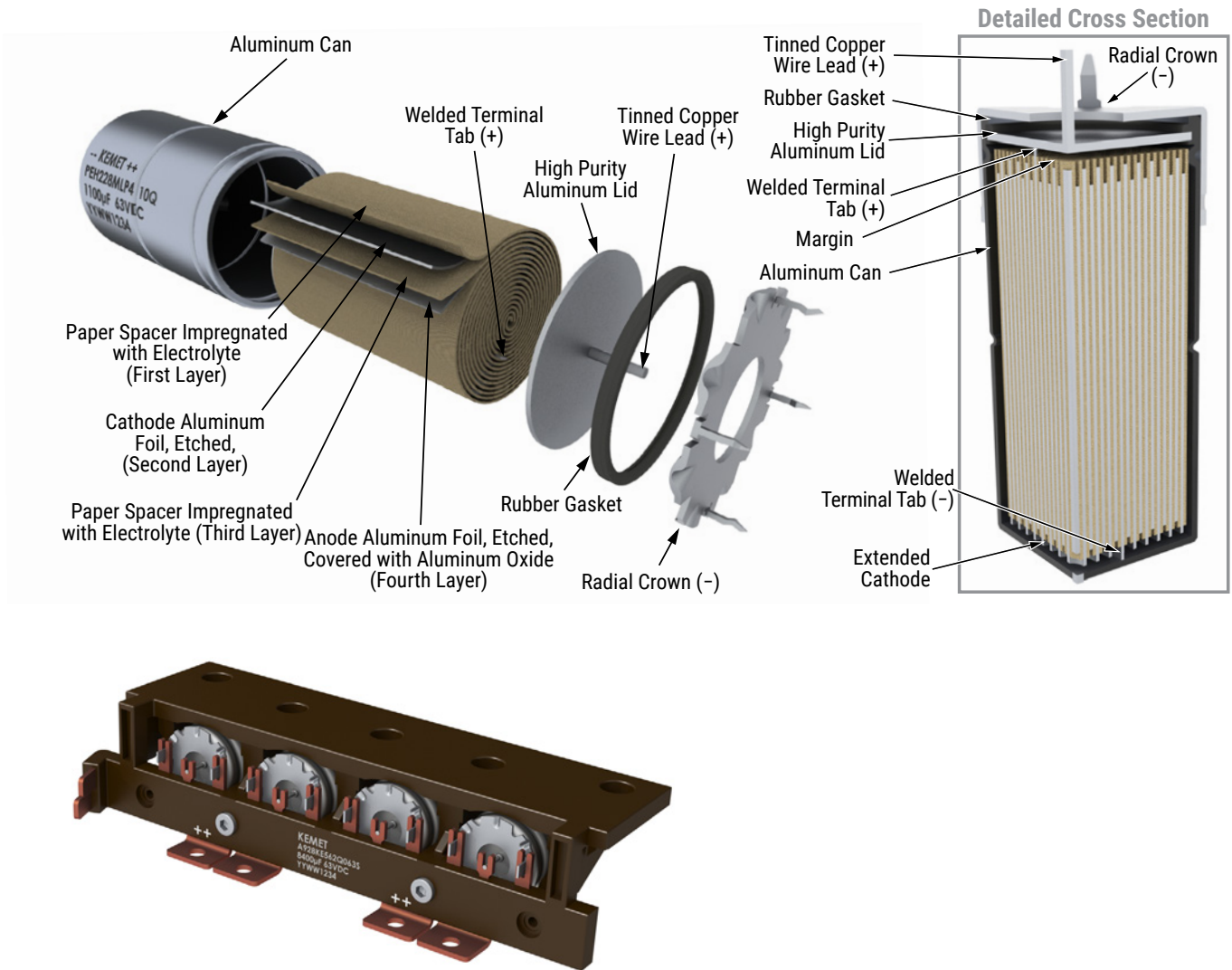

Construction Data

The manufacturing process begins with the anode foil being electrochemically etched to increase the surface area and then “formed” to produce the aluminum oxide layer. Both the anode and cathode foils are then interleaved with absorbent paper and wound into a cylinder. During the winding process, aluminum tabs are attached to each foil to provide the electrical contact.

The winding is assembled to the capacitor Al-can and to the Al-lid. The can is filled with electrolyte and the winding is impregnated during a vacuum treatment. The capacitor is sealed. Throughout the process, all materials inside the housing must be maintained at the highest purity and be compatible with the electrolyte.

Each capacitor is aged and tested before being packed. The purpose of aging is to repair any damage in the oxide layer and thus reduce the leakage current to a very low level. Aging is carried out at elevated temperature and is accomplished by applying voltage to the device while carefully controlling the supply current. The process takes between 2 and 20 hours, depending on voltage rating.

Damage to the oxide layer can occur due to a variety of reasons:

- Slitting of the anode foil after forming
- Attaching the tabs to the anode foil
- Minor mechanical damage caused during winding

The following tests are applied for each individual capacitor.

Electrical:

- Leakage current
- Capacitance
- ESR
- Tan Delta

Mechanical/Visual:

- Pull strength test of wire terminals
- Print detail
- Box labels
- Packaging, including packed quantity

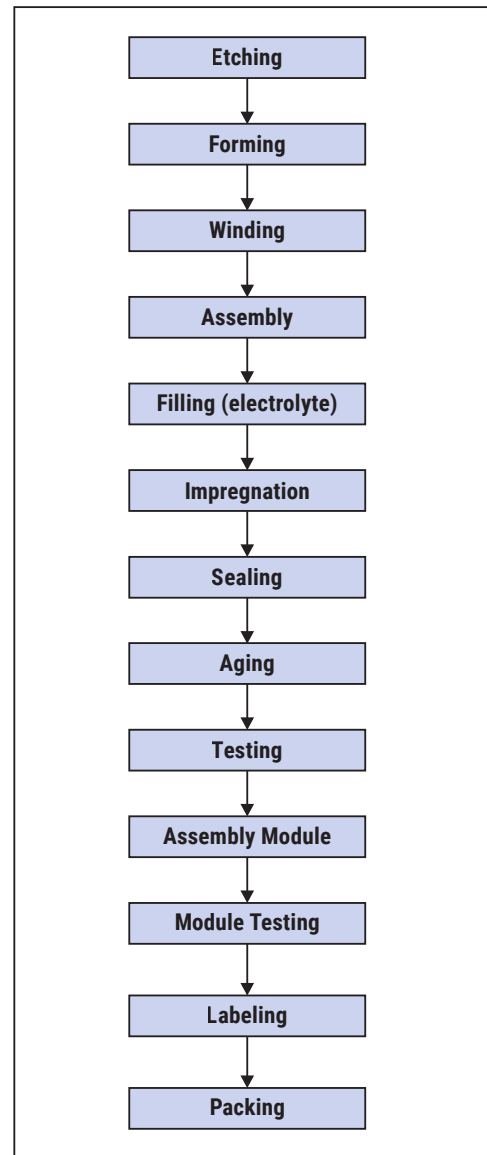
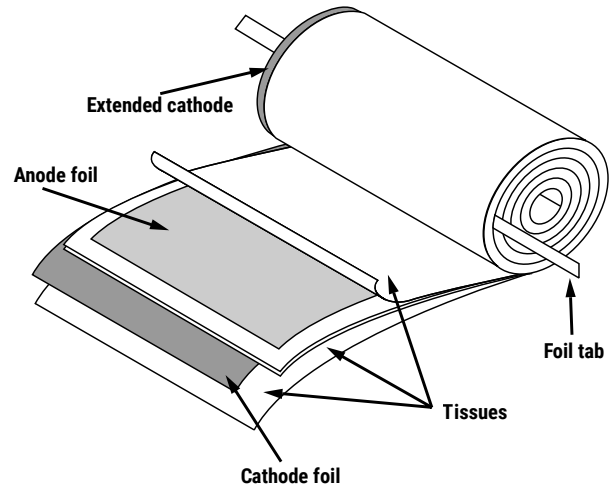

KEMET Electronics Corporation Sales Offices

For a complete list of our global sales offices, please visit www.kemet.com/sales.

Disclaimer

All product specifications, statements, information and data (collectively, the "Information") in this datasheet are subject to change. The customer is responsible for checking and verifying the extent to which the Information contained in this publication is applicable to an order at the time the order is placed. All Information given herein is believed to be accurate and reliable, but it is presented without guarantee, warranty, or responsibility of any kind, expressed or implied.

Statements of suitability for certain applications are based on KEMET Electronics Corporation's ("KEMET") knowledge of typical operating conditions for such applications, but are not intended to constitute – and KEMET specifically disclaims – any warranty concerning suitability for a specific customer application or use. The Information is intended for use only by customers who have the requisite experience and capability to determine the correct products for their application. Any technical advice inferred from this Information or otherwise provided by KEMET with reference to the use of KEMET's products is given gratis, and KEMET assumes no obligation or liability for the advice given or results obtained.

Although KEMET designs and manufactures its products to the most stringent quality and safety standards, given the current state of the art, isolated component failures may still occur. Accordingly, customer applications which require a high degree of reliability or safety should employ suitable designs or other safeguards (such as installation of protective circuitry or redundancies) in order to ensure that the failure of an electrical component does not result in a risk of personal injury or property damage.

Although all product-related warnings, cautions and notes must be observed, the customer should not assume that all safety measures are indicated or that other measures may not be required.

KEMET is a registered trademark of KEMET Electronics Corporation.