

SCT-XV & SCR-XV Common Mode Choke Coils, 12 – 15 A, High Voltage, AEC-Q200 Automotive Kit

Sample Kit Contents

KEMET Part Number	Rated Voltage AC/DC (V)	Rated Current (A)	Inductance (mH) $\pm 30\%$	DC Resistance/ Line (m Ω) $\pm 13\%$	Temperature Rise (K) Maximum	Quantity	Description
SCT19XV-120-1R2A007JV	1,000	12	0.180	3.99	50	2	Common Mode SCT-XV Coils, Automotive Grade, -40/+150°C
SCT19XV-150-1R3A006JV	1,000	15	0.134	2.91	50	2	Common Mode SCT-XV Coils, Automotive Grade, -40/+150°C
SCT25XV-130-1R5A012JV	1,000	13	1.150	6.33	55	2	Common Mode SCT-XV Coils, Automotive Grade, -40/+150°C
SCT25XV-150-1R6A010JV	1,000	15	0.800	4.62	50	2	Common Mode SCT-XV Coils, Automotive Grade, -40/+150°C
SCT29XV-120-1R6A017JV	1,000	12	0.960	6.43	40	2	Common Mode SCT-XV Coils, Automotive Grade, -40/+150°C
SCT29XV-150-1R7A015JV	1,000	15	0.750	5.04	55	2	Common Mode SCT-XV Coils, Automotive Grade, -40/+150°C
SCR19XV-120-1R2A007JV	1,000	12	0.300	3.99	50	2	Common Mode SCR-XV Coils, Automotive Grade, -40/+120°C
SCR19XV-150-1R3A006JV	1,000	15	0.220	2.91	50	2	Common Mode SCR-XV Coils, Automotive Grade, -40/+120°C
SCR25XV-130-1R5A012JV	1,000	13	1.770	6.33	55	2	Common Mode SCR-XV Coils, Automotive Grade, -40/+120°C
SCR25XV-150-1R6A010JV	1,000	15	1.230	4.62	50	2	Common Mode SCR-XV Coils, Automotive Grade, -40/+120°C
SCR29XV-120-1R6A017JV	1,000	12	1.760	6.43	40	2	Common Mode SCR-XV Coils, Automotive Grade, -40/+120°C
SCR29XV-150-1R7A015JV	1,000	15	1.370	5.04	55	2	Common Mode SCR-XV Coils, Automotive Grade, -40/+120°C
KEMET Part Number	Rated Voltage AC/DC (V)	Rated Current (A)	Inductance (mH) $\pm 30\%$	DC Resistance/ Line (m Ω) $\pm 13\%$	Temperature Rise (K) Maximum	Quantity	Description

Dimensions – Millimeters

Figure 1

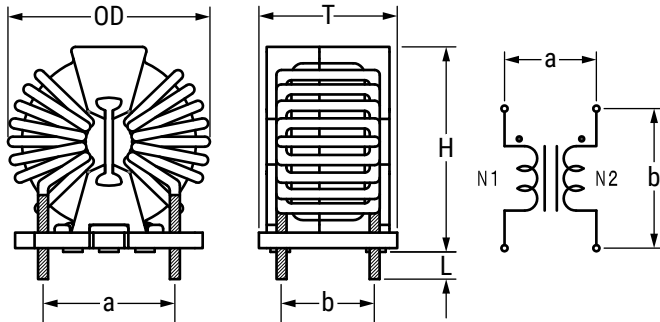
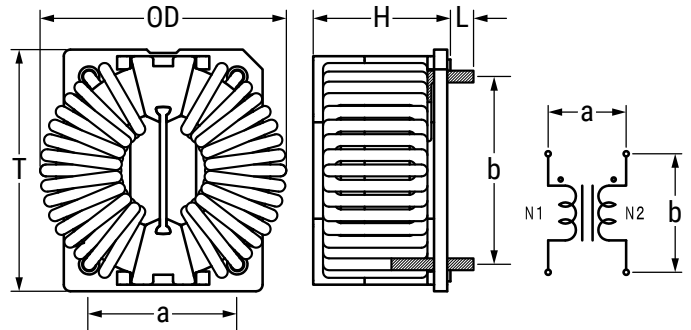

Figure 2



Part Name	Dimensions (mm)				Pin Pitch ¹ (Reference)		Figure
	OD (Maximum)	T (Maximum)	H (Maximum)	L	a	b	
SCR19-JV / SCT19-JV	27.0 / 28.0	18.4	27.5	3.50 ±0.5	17.0	12.0	Fig. 1
SCR25-JV / SCT25-JV	34.0 / 35.5 / 37.5	26.0	33.5	3.50 ±0.5	20.5	18.5	
SCR29-JV / SCT29-JV	39.0 / 40.5 / 41.5	21.4	37.7	3.50 ±0.5	22.5	13.5	
SCR19-JH / SCT19-JH	27.0 / 28.0	27.0	18.9	3.50 ±0.5	17.0	19.0	Fig. 2
SCR25-JH / SCT25-JH	34.0 / 35.5 / 37.5	33.0	26.5	3.50 ±0.5	20.5	24.5	
SCR29-JH / SCT29-JH	39.0 / 40.5 / 41.5	37.2	21.9	3.50 ±0.5	22.5	28.5	

¹ Pin pitch listed above for reference only. Values not guaranteed.

KEMET Electronics Corporation Sales Offices

For a complete list of our global sales offices, please visit www.kemet.com/sales.

Disclaimer

YAGEO Corporation and its affiliates do not recommend the use of commercial or automotive grade products for high reliability applications or manned space flight.

All product specifications, statements, information and data (collectively, the "Information") in this datasheet are subject to change. The customer is responsible for checking and verifying the extent to which the Information contained in this publication is applicable to an order at the time the order is placed. All Information given herein is believed to be accurate and reliable, but it is presented without guarantee, warranty, or responsibility of any kind, expressed or implied.

Statements of suitability for certain applications are based on KEMET Electronics Corporation's ("KEMET") knowledge of typical operating conditions for such applications, but are not intended to constitute – and KEMET specifically disclaims – any warranty concerning suitability for a specific customer application or use. The Information is intended for use only by customers who have the requisite experience and capability to determine the correct products for their application. Any technical advice inferred from this Information or otherwise provided by KEMET with reference to the use of KEMET's products is given gratis, and KEMET assumes no obligation or liability for the advice given or results obtained.

Although KEMET designs and manufactures its products to the most stringent quality and safety standards, given the current state of the art, isolated component failures may still occur. Accordingly, customer applications which require a high degree of reliability or safety should employ suitable designs or other safeguards (such as installation of protective circuitry or redundancies) in order to ensure that the failure of an electrical component does not result in a risk of personal injury or property damage.

Although all product-related warnings, cautions and notes must be observed, the customer should not assume that all safety measures are indicated or that other measures may not be required.

When providing KEMET products and technologies contained herein to other countries, the customer must abide by the procedures and provisions stipulated in all applicable export laws and regulations, including without limitation the International Traffic in Arms Regulations (ITAR), the US Export Administration Regulations (EAR) and the Japan Foreign Exchange and Foreign Trade Act.

KEMET is a registered trademark of KEMET Electronics Corporation.